

# ANDRIA

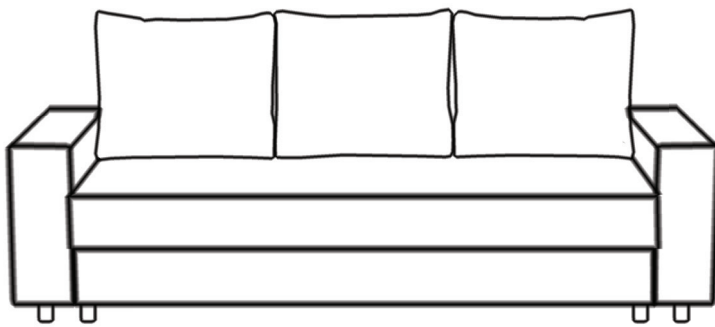

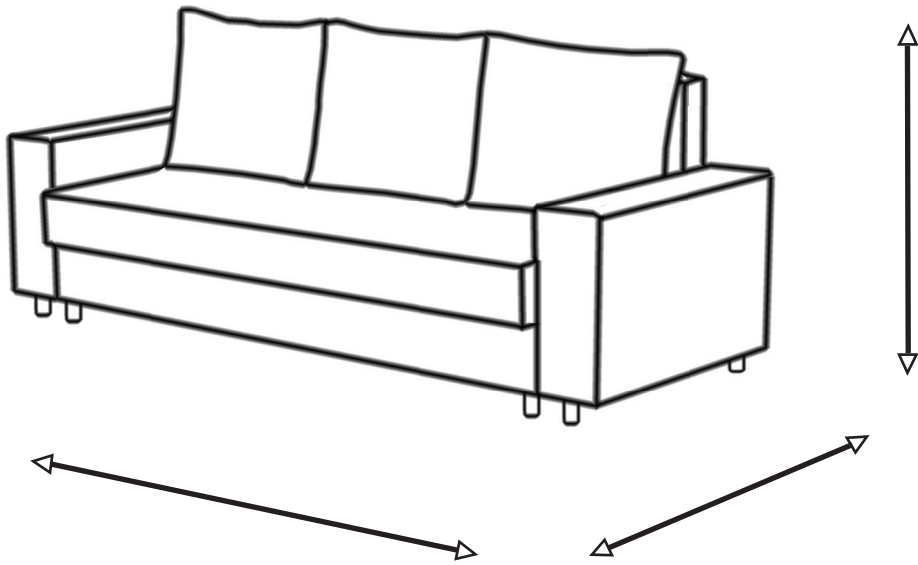
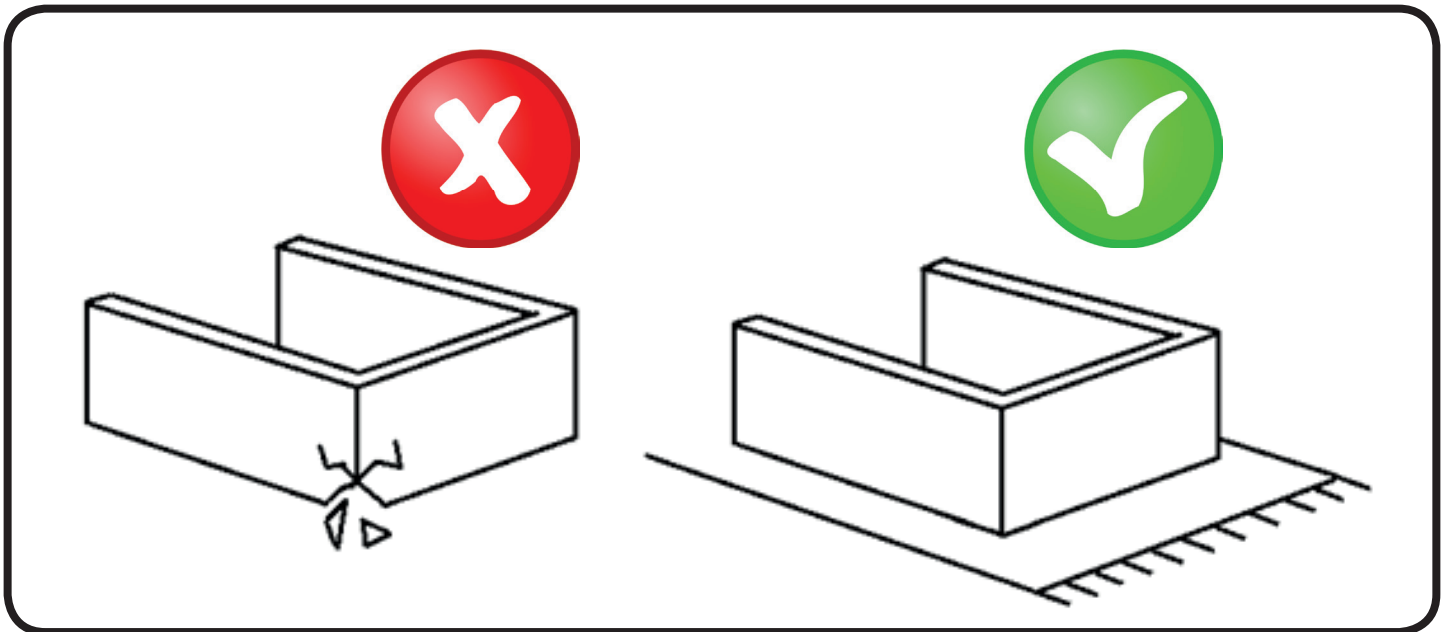

**GB: WARNING TO AVOID SCRATCHES!**

In order to avoid scratching this furniture should be assembled on a soft layer - could be a rug.  
**IMPORTANT!**

It is important that any product which is assembled using any kind of screw is re-tightened 2 weeks after assembly, and once every 3 months - in order to assure stability through-out the lifespan of the product.

**DK: ADVERSEL FOR AT FORHINDRE RIDSER!**

For at forhindre ridser skal dette møbel samles på et blødt underlag, f.eks. et tæppe.  
**VIGTI GT!**

Det er vigtigt, at alle produkter, der samles med alle former for skruer, efterspændes to uger efter samling samt hver tredje måned for at sikre, at produktet er stabilt i hele dets levetid.

**PL: OSTRZEŻENI E WS. USZKODZEN!**

Aby uniknąć rys, ten mebel powinien być montowany, składani na miękkim podłożu, np. dywanie.

**WAŻNE!**

Ważne jest, żeby każdy ze skręcanych produktów został ponownie dokręcony w ciągu 2 tygodni od montażu, a następnie sprawdzać co 3 miesiące czy śruby są dokręcone - w celu zapewnienia stabilności przez czas użytkowania produktu.

**HU: KARCOLÁSOK MEGELŐZÉSE - FIGYELEM!**

A karcolások megelőzése érdekében a bútort puha felületen, például szőnyegen kell összeszerelni.

**FONTOS!**

Minden terméknél fontos, hogy bármilyen fajta csavarral is történik az összeszerelés, utána két héttel, majd 3 havi rendszerességgel szükséges a csavarok utánhúúzása. Ezzel a termék teljes élettartalmán keresztül biztosítható a stabilitása.

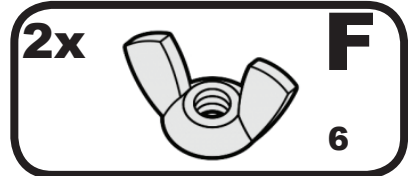
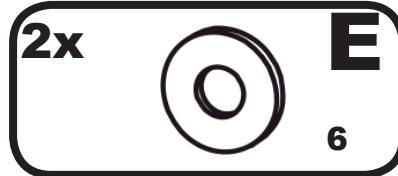
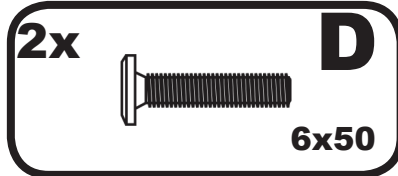
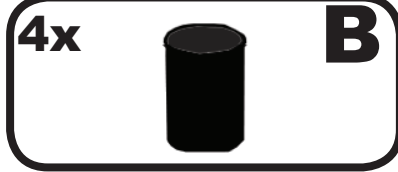
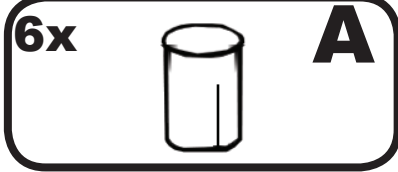
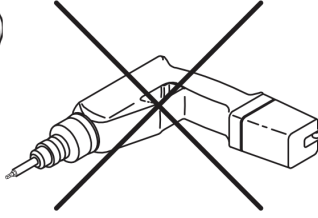
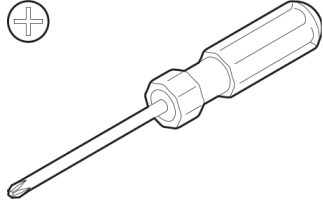

**1.**



**2.**

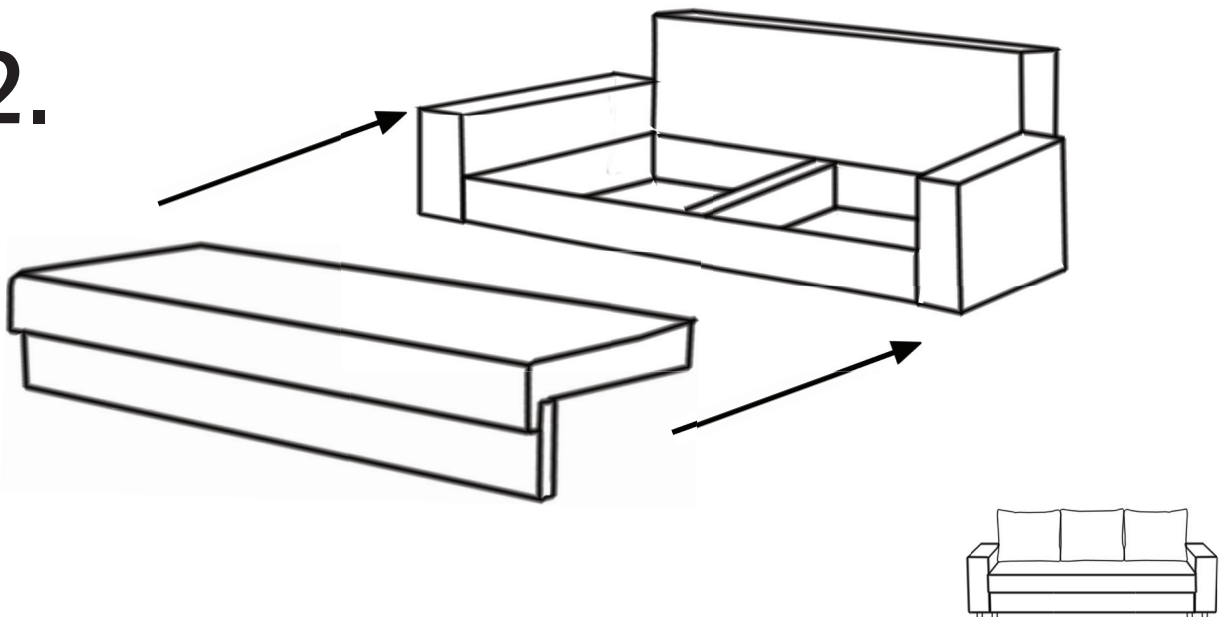

3.

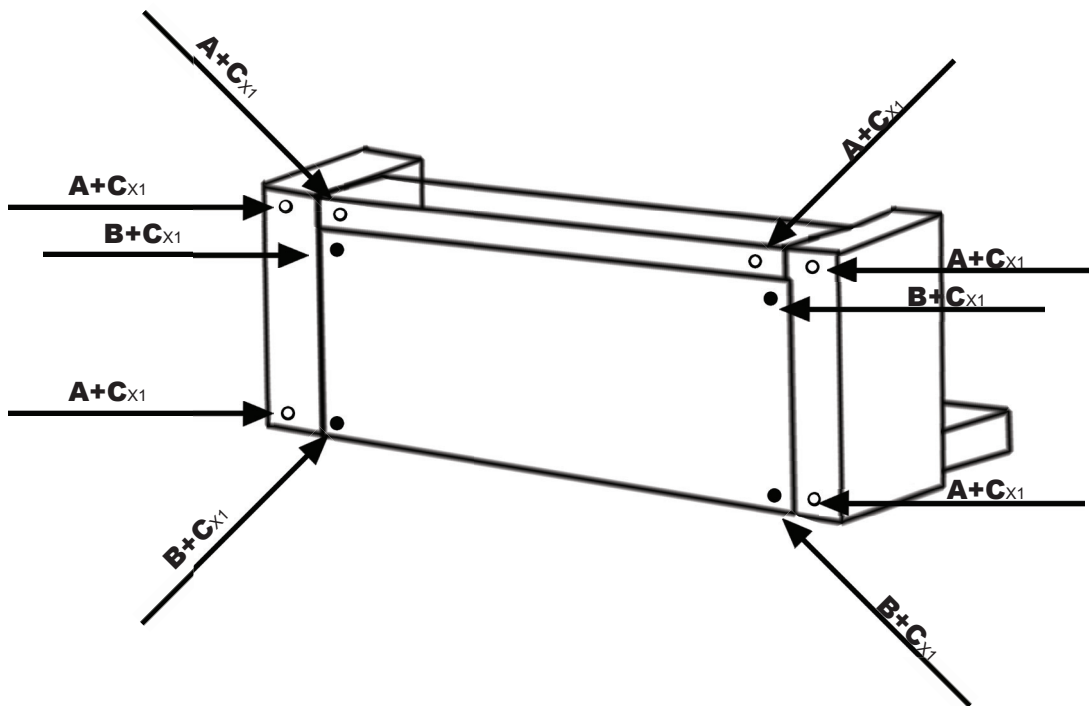
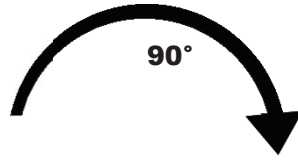
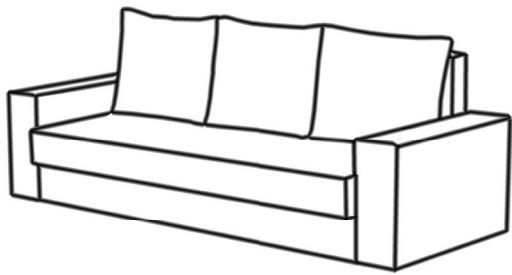

4.

